

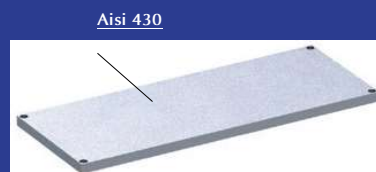

Estanterias de acero inoxidable



mod.	mm.		
P400 mm.			
LSMR4P10-4	1000x400x1800H	22	0,13
LSMR4P13-4	1300x400x1800H	30	0,16
LSMR4P16-4	1600x400x1800H	34	0,18
P500 mm.			
LSMR4P10-5	1000x500x1800H	26	0,15
LSMR4P13-5	1300x500x1800H	34	0,2
LSMR4P16-5	1600x500x1800H	38	0,24
P700 mm.			
LSMR4P10-7	1000x700x1800H	30	,22
LSMR4P13-7	1300x700x1800H	42	0,27
LSMR4P16-7	1600x700x1800H	50	0,33

Ogni scaffale ha in dotazione nr^o 4 ripiani | each shelf unit is provided with 4 shelves
 | chaque rayonnage dispose de 4 étagères de série | Mit jedem Regal werden 4 Böden
 mitgeliefert | Cada estante tiene en dotación nr^o 4 anaqueles

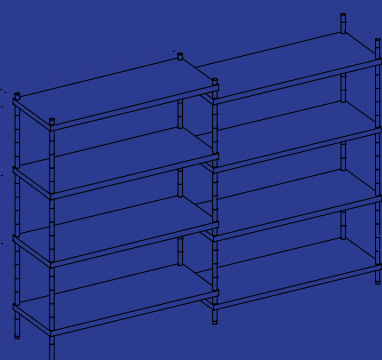

mod.	mm.		
P400 mm.			
LRS4-10	1000x400x40H	6	0,02
LRS4-13	1300x400x40H	8	0,03
LRS4-16	1600x400x40H	11	0,04
P500 mm.			
LRS5-10	1000x500x40H	8	0,02
LRS5-13	1300x500x40H	10	0,03
LRS5-16	1600x500x40H	13	0,04
P700 mm.			
LRS7-10	1000x700x40H	11	0,02
LRS7-13	1300x700x40H	13	0,03
LRS7-16	1600x700x40H	16	0,04

Ripiani aggiuntivi | Additional shelves | Étagères
 supplémentaires | Zusätzliche Böden | Anaqueles adicional

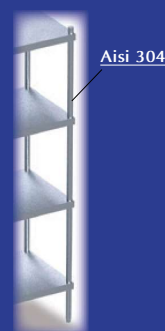

Esempio di componibilità | Composition
 sample Exemple de modulabilité |
 Anbaubeispiel Ejemplo de composition



mod.	mm.		
LMS2-18	øx30x1800H	6	0,01

nr. 2 montanti aggiuntivi | nr. 2 additional risers | nr. 2 montants
 sup-plémentaires | 2 zusätzliche Pfosten | nr. 2 montantes adicional

Neutro UNI - GN1/1

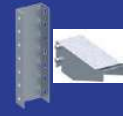

Ripiani | Shelves | Étagères |
Böden | Anaqueles | Prateleiras

Ripiani forati | Pierced shelves |
Étagères perforées | Gestanzte Böden |
Anaqueles pinchados | Prateleiras furadas

L mm.	mod. P=300	mod. P=400	mod. P=300	mod. P=400	Q.tà	Q.tà	Q.tà	Q.tà
400	MMS3-04	MMS4-04	MMG3-04	MMG4-04	2	2	2	4
500	MMS3-05	MMS4-05	MMG3-05	MMG4-05	2	2	2	4
600	MMS3-06	MMS4-06	MMG3-06	MMG4-06	2	2	2	4
700	MMS3-07	MMS4-07	MMG3-07	MMG4-07	2	2	2	4
800	MMS3-08	MMS4-08	MMG3-08	MMG4-08	2	2	2	4
900	MMS3-09	MMS4-09	MMG3-09	MMG4-09	2	2	2	4
1.000	MMS3-10	MMS4-10	MMG3-10	MMG4-10	2	2	2	4
1.100	MMS3-11	MMS4-11	MMG3-11	MMG4-11	2	2	2	4
1.200	MMS3-12	MMS4-12	MMG3-12	MMG4-12	2	2	2	4
1.300	MMS3-13	MMS4-13	MMG3-13	MMG4-13	2	2	2	4
1.400	MMS3-14	MMS4-14	MMG3-14	MMG4-14	2	2	2	4
1.500	MMS3-15	MMS4-15	MMG3-15	MMG4-15	3	3	3	6
1.600	MMS3-16	MMS4-16	MMG3-16	MMG4-16	3	3	3	6
1.700	MMS3-17	MMS4-17	MMG3-17	MMG4-17	3	3	3	6
1.800	MMS3-18	MMS4-18	MMG3-18	MMG4-18	3	3	3	6
1.900	MMS3-19	MMS4-19	MMG3-19	MMG4-19	3	3	3	6
2.000	MMS3-20	MMS4-20	MMG3-20	MMG4-20	3	3	3	6
2.100	MMS3-21	MMS4-21	MMG3-21	MMG4-21	3	3	3	6
2.200	MMS3-22	MMS4-22	MMG3-22	MMG4-22	4	4	4	8
2.300	MMS3-23	MMS4-23	MMG3-23	MMG4-23	4	4	4	8
2.400	MMS3-24	MMS4-24	MMG3-24	MMG4-24	4	4	4	8
2.500	MMS3-25	MMS4-25	MMG3-25	MMG4-25	4	4	4	8

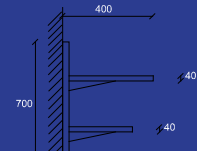
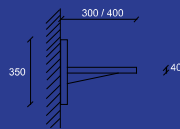

mod.	mm.
CRM-70	40x30x700H
CRM-35	40x30x350H

Cremagliera | Rack | Crémaillère | Wandschiene | Cremallera

mod.	mm.
SMENS-3	35x312x70H
SMENS-4	35x412x70H

Mensola | Bracket | Support | Konsole | Repisa

N.B. I prezzi dei ripiani non comprendono le cremagliere e le mensole; in tabella sono riportate le quantità suggerite in funzione della lunghezza degli stessi ripiani

N.B. The prices of the shelves do not include shelf racks and supports; the chart shows the quantities suggested as a function of the length of the same shelves. Les

N.B. prix des étagères ne comprennent pas les montants et les supports ; dans le tableau il y a les quantités conseillées en fonction de la longueur des étagères. In

N.B. den Preisen der Wand-Regale sind die Zahnstangen und Konsolen nicht mit inbegriffen; in der Tabelle ist die Anzahl, die für die einzelnen Längen nötig sind, angegeben.

N.B. Los precios no incluyen estantes y cremalleras; en la tabla hay cantidades considerando las dimensiones de los mismos